

TPU Injection Molding Processing Guide





Injection Molding Processing Guide



CONTENTS

- Introduction.....2
- Equipment Requirements.....4
- Mold and Part Design..... 6 - 8
- The Molding Operation.....8- 11
- Summary..... 12
- Start-Up Procedure..... 12
- Trouble Shooting Guide.....13

INTRODUCTION

This brochure is intended to provide general guidelines for equipment, procedures and molding machine conditions that will help the customer to obtain the best possible performance from Lubrizol TPU. Additionally, you can consult the technical data sheets of our products or contact our technical service.

Lubrizol's portfolio of injection molding grades includes Estane® TPU (thermoplastic polyurethane), Pearlthane™ TPU, Isoplast® ETP (engineered thermoplastic), and Estaloc™ RETPU (reinforced thermoplastic polyurethane). Lubrizol offers soft grades, in the shore hardness range of 70A to 90A, that have a low modulus of elasticity and excellent retention of flexibility at very low temperatures. Additionally, Lubrizol offers harder TPU grades, in the shore hardness range of 50D to 70D, that have a high modulus of elasticity, and excellent low temperature impact strength.

At Lubrizol Engineered Polymers, we are open to new opportunities and are always willing to collaborate with our customers and partners to develop more sustainable solutions. Lubrizol TPU is recyclable*. As we make progress in our sustainability journey, our Bio TPU portfolio has been expanded and we have launched a mass balance solution:

- Our bio-based portfolio for molding, over molding, and extrusion processes is commercialized as ESTANE® ECO TPU, and shows better performance than our petroleum-based TPU grades in some end applications.
- ESTANE RNW TPU is a specialty TPU with the same high quality and performance as ESTANE TPU, while using bio and/or mass balanced feedstocks.

All materials produce a very low-viscosity melt that easily fills the most complex mold cavities under low injection pressure. The low viscosity melt permits the material to flow through small gates and into thin wall sections under low injection pressure. Low-viscosity melt combined with low injection pressure minimizes the possibility of producing highly stressed parts. This is significant because many new thermoplastic polyurethane molded parts are painted, and paint systems require baking for 30 minutes at 122°C (250°F). Under these conditions, any molded-in stresses would relieve and the result would be a distorted part. To eliminate this distortion, a time period of 48 hours is recommended before subjecting the molded part to a bake oven.

Key Benefits of Lubrizol Engineered Polymers TPU:

- Abrasion, Impact and Puncture Resistance
- Antimicrobial, and Fungal Resistance
- Bio-based and Recyclable*
- Chemical and Hydrolysis Resistance
- Easy-to-Extrude
- Electrostatic Dissipative (ESD)
- Non-Halogenated Flame Retardancy
- High Moisture Vapor Transmission
- Optical Clarity
- Skin Compatible
- Soft Elastic
- UV Resistance and/or Filtering
- Wide Hardness Range (52A to 88D) and Polymer Compatibility

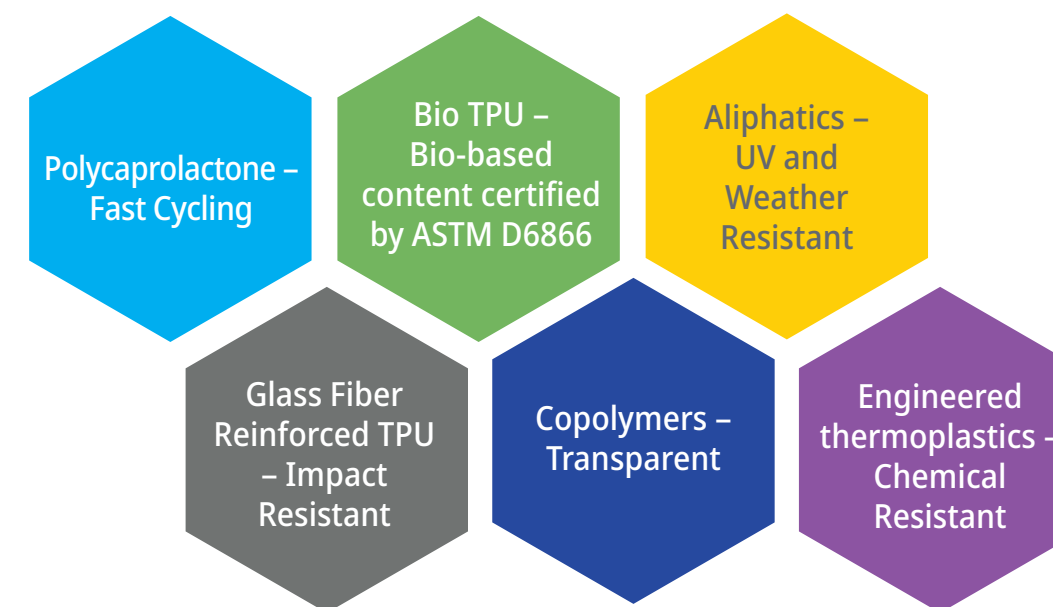

*Recyclability is based on access to a readily available standard recycling program that supports such materials. Products may not be available in all areas.

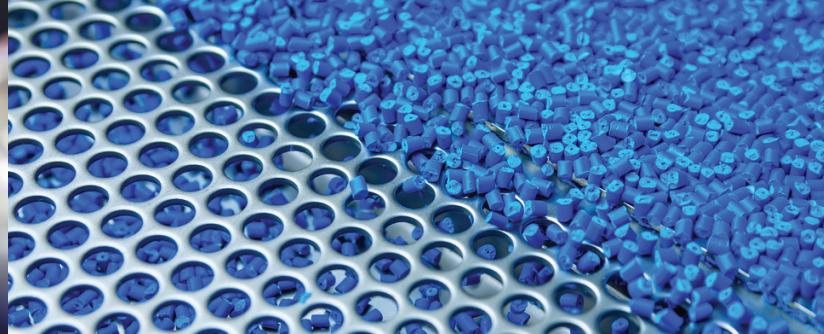
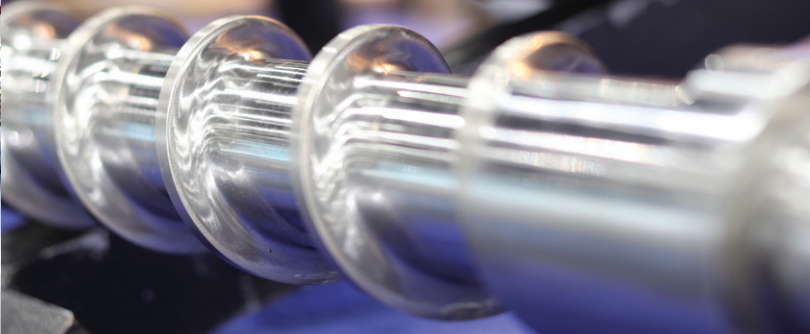
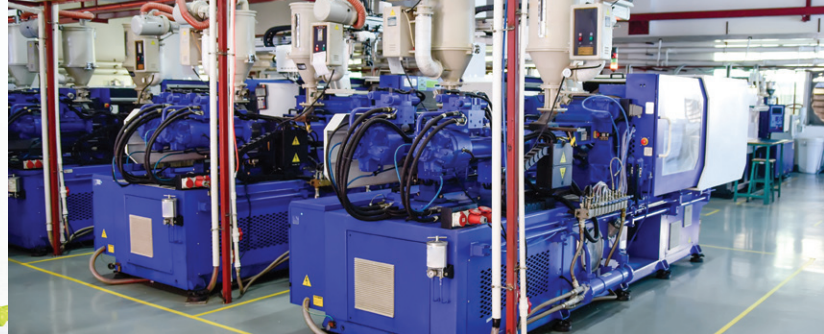

Equipment Requirements

TYPE OF MACHINE

Although all types of machines have been successfully used, a reciprocating-screw machine is preferred for molding lubrizol tpus. A reciprocating-screw machine is capable of producing the most uniform melt, is the most easily controlled, and is capable of the fastest cycles.

MACHINE SIZE

Barrel capacity: to obtain the widest processing latitude and optimum physical properties, an appropriate match of shot size, (i.e., Volume of cavities, runners and sprue) to barrel capacity is very desirable. A shot weight of at least 50% of barrel capacity is recommended. This minimizes melt residence time in the barrel enabling processing at higher stock temperatures with optimum melt flow while avoiding degradation.

Since the optimum match of barrel capacity is not always practical due to clamp requirements or machine availability, shot sizes as low as 30 to 35% may be used with the understanding that the processing latitude of the material may be significantly reduced. Lower stock temperatures mean higher melt viscosity and more resistance to flow. Greater injection pressures will be needed to fill the part and molded-in stresses may result. It is likely that these molded-in stresses could adversely affect impact, dimensional stability and other properties of the finished part.

When calculating optimum barrel capacity, always consider the specific gravity of the TPU versus the specific gravity of the material for which the machine was rated. Most machines are normally rated for kilograms (ounces), a unit of weight of general-purpose polystyrene.

EXAMPLE:

Given that the specific gravities of Lubrizol TPUs and general purpose polystyrene are 1.20 and 1.05 respectively, a 1.7 kg (60 oz. avoirdupois) barrel rated in general purpose polystyrene will deliver 1.9 kg (67 oz.)* of TPU.

$$*1.7 \text{ kg} \times 1.2 = 1.9 \text{ kg (67 oz.)}$$

$$1.05$$

A targeted shot weight, including sprue, runners and parts, would then be 1.4 kg (50 oz.) on this machine.
(1.9 kg x 75% capacity = 1.4 kg or 50 oz.)

CLAMP CAPACITY

A new machine having a minimum clamp force of 300 to 400 kg/cm² (2 to 3 tons/square inch) of projected part area, including runners, is recommended. The area of runners in a three-plate mold should be included.

SCREW AND TIP

The type of screw and tip design that most manufactures call "general purpose" is best. The compression ratio of most of the general-purpose screws falls between 2:1 and 3:1 and this range is the most desirable for plasticizing Lubrizol TPUs. The general-purpose tip usually has a 60° included angle and an anti-backflow mechanism of either the ball check or sliding ring type. It is recommended that an anti-backflow valve, in good working order, be used when Lubrizol TPUs are molded. The extremely low viscosity of their melts makes satisfactory packing-out of the mold cavity very difficult unless an anti-backflow device is used.

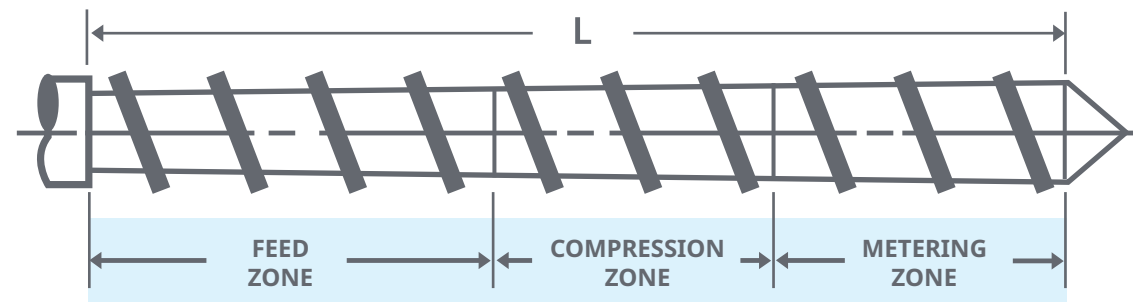

ZONE	LENGTH
FEED ZONE	7-9D
COMPRESSION	10-12D
METERING	8-9D

TOTAL 25-30D

Compression ratio 2.5-3.0 MQ recommendation

PVC, PE
screws OK

PA screws
are NOT OK

NOZZLES

A straight, open nozzle with a full internal taper tip is recommended. A positive shut off, anti-drool nozzle can be helpful, but is not a necessity. If the particular machine or mold design requires a long nozzle or a nozzle extension, it should be well insulated with heater bands so that there are no cold spots. The harder Lubrizol TPUs, because of their sharp melting point, can be set up if a cold spot exists.

The result will be in the next shot, cold slugs of material will be carried into the cavity along with the hot melt. The longer the cycle required by the particular part, the more troublesome this can become; therefore, the nozzle must be well insulated with heater bands. The bands must extend as close to the tip as possible. backflow mechanism of either the ball check or sliding ring type. It is recommended that an anti-backflow valve, in good working order, be used when Lubrizol TPUs are molded. The extremely low viscosity of their melts makes satisfactory packing-out of the mold cavity very difficult unless an anti-backflow device is used.

MOLDS

Any type of mold that incorporates good thermoplastic design principles is satisfactory for Lubrizol TPUs. Two-plate, three-plate and hot-runner molds have all been successfully used for a variety of large and small parts. For hot-runner molds, as with nozzles, it is important that heaters provide full coverage of the runner system so that cold spots do not exist and the TPU can be maintained in its fluid melt state. The mold must also be adequately cored for cooling because Lubrizol TPUs normally require a relatively cool mold (10°C to 80°C) (50°F to 140°F) to produce optimum cycle. The nozzle tips within the hot runner mold must be well insulated from the cold side of the mold. Poor insulation and the quick set-up characteristics of Lubrizol TPUs can lead to plugged nozzles. A sheet of transite separating the hot and cold sections of the mold is recommended.

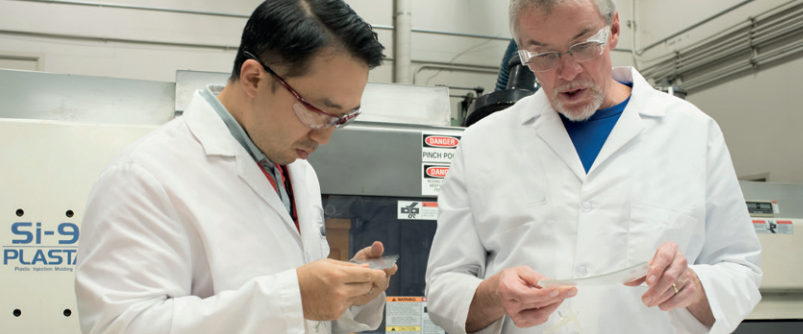

Mold and Part Design

SPRUE BUSHING

A sprue bushing with a standard 21/2° included angle, approximately 42 mm taper per meter (0.5 in. taper per foot) should be used. The entrance diameter of the bushing should always be slightly larger than the nozzle exit orifice. To promote a balanced pressure to the runners and cavities, the exit diameter of sprue bushing should be larger than the diameter of the main runner.

RUNNERS

In a two-plate mold, full-round runners are preferred because they provide the highest volume-to-surface ratio, the least pressure drop, and are the easiest to eject from the mold. Depending on the part size and weight, typical full-round runner diameters are 0.6 to 1.0 cm (0.25 to 0.4 in.). Because of excessive flow restriction, small diameter runners, less than 0.6 cm (0.25 in.) diameter, should be avoided. Excessively large diameter runners offer little advantage and contribute to longer cycle times and greater material usage. If a three-plate mold is being used, full-round runners are still preferred, but trapezoidal runners can be used.

FIGURE 1

shows typical relative dimensions of a trapezoidal crosssection runner. The flow through a trapezoidal runner is equivalent to that of the largest circular runner whose cross-section can be inscribed with the trapezoid.

To maintain pressure and balanced flow during injection into a multiple cavity or multigated mold, the secondary runners should be slightly smaller in cross section than the main runner. Secondary runners should be perpendicular to the main runner, and the runner junction should be vapor-honed to remove burrs and sharp edges, and contain a cold slug well at every turn of direction.

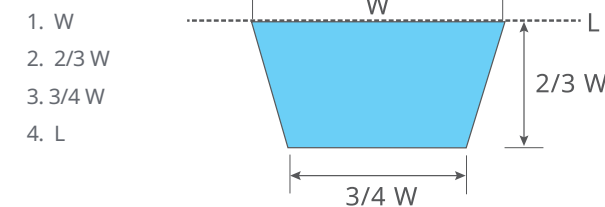

Figure 1: Relative Dimensions of a Trapezoidal Runner for use in a Three-plate Mold

1. Spruce Larger than Main Runner
2. Secondary Runner Smaller than Main Runner
3. Cold Slug Well
4. No Cold Slug Well
5. Unbalanced Flow Length to Cavities

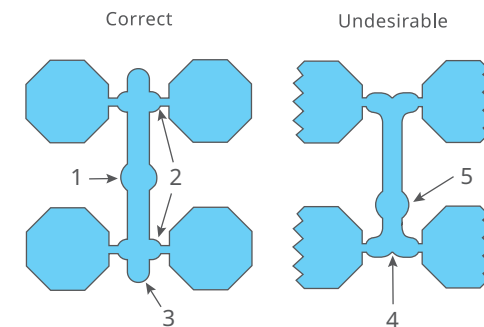

Figure 2: Proper Running Sizing

FIGURE 2

shows a properly sized runner system.

In addition to proper runner sizing, the layout of the mold is also an important consideration. A runner system should be designed to give balanced flow to all gates, ideally designed so that the melt reaches all of the gates simultaneously. Although not recommended in certain cases, Lubrizol TPUs may be used in a hot-runner system provided that the mold designer has had prior successful experience in overcoming the special problem the system represents.

1. Balanced-Flow Cavities
2. Cold Slug Wells

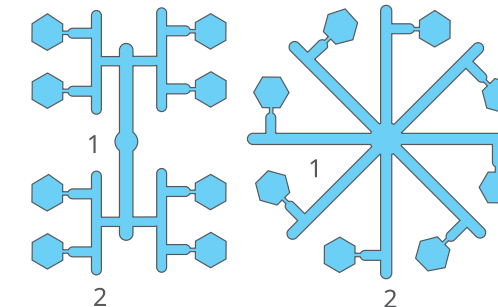

Figure 3: Runner Systems with balanced-flow Cavity Layouts and Cold Slug wells

COLD SLUG WELLS

During injection, the initial surge of material is generally cool since it has remained dormant in the nozzle while the previous shot was being ejected from the mold. To prevent this cold material from entering the cavity and causing a visual defect, cold slug wells or runoffs should be incorporated into the runner system before material is allowed to enter the cavities. Properly sized runner systems designed for balanced flow which incorporate cold slug wells are shown in Figure 3.

GATES

Lubrizol TPUs have been satisfactorily molded through a wide variety of gate designs including fan, tab, edge, submarine and sprue. In general, the gates should have a generous crosssectional area to allow the material to flow freely with a minimum of pressure loss. The gates should be vapor-honed with all rough edges and sharp corners removed. Figure 4 illustrates several acceptable gate designs with rounded corners for minimum restriction.

Tab gates are strongly recommended for the softer grades of Lubrizol TPUs. They eliminate the distortion in the gate area that commonly occurs with very flexible materials. The use of pinpoint gates and tunnel gates should be restricted to very small parts of a few ounces or less in weight where the flow length from the gate is less than 5.08 cm (2 in.). The land length of gates should always be as short as possible. A good rule of thumb for determining the proper land length is that it should be no greater than one half the gate thickness.

1. Sprue Gate
2. Fan Gate
3. Submarine Gate
4. Flash Gate
5. Pin Gate
6. Tab Gate
7. Edge Gate
8. Ring Gate

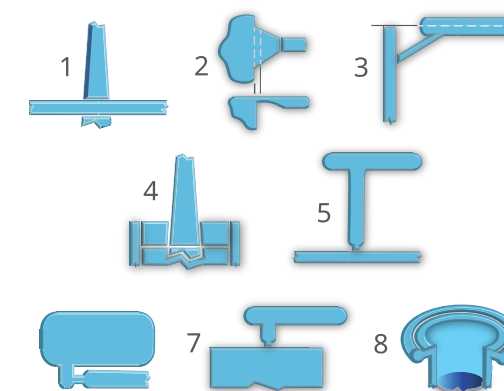

Figure 4: Gate Designs

In multi-gated cavities, the gate location and number of gates are very important in relation to the appearance and performance of the molded part. Since gate areas are almost always more highly stressed due to orientation, gates should be located in non-critical sections of the part. Gating in thick sections of the part and allowing the material to flow to the thinner sections keeps sink marks to a minimum. When gating into a thick section, the flow should be directed toward a cavity wall or deflector pin to break up the melt entering the cavity and to prevent a condition called 'worming'. Worming is a random pattern of weld lines opposite the gate caused by the rapid cooling of the injection melt. If the design of the part requires a split in the flow front coming from the gate, a weld line will usually result when the flow fronts meet. Care should be taken in designing parts to keep the number of gates to a minimum to minimize weld lines. Multiple weld lines could detract from the surface appearance and may affect performance.

MOLD SHRINKAGE

Mold design, part design, and operating conditions all affect the mold shrinkage value of any thermoplastic material. In cases where very close tolerance must be maintained, it is suggested that a prototype tool be made before building the production tool. Where standard or coarse tolerances are all that is required, the standard mold shrinkage allowance for the particular Lubrizol TPUs should be used. It should be noted, post annealing or exposing parts to a point over temperature, will increase the mold shrinkage from what is normally expected. This data is presented in technical data sheets of Lubrizol TPUs for molding.



Mold and Part Design

EJECTION OF THE PART

Lubrizol TPUs release easily from properly prepared mold surfaces. Highly polished, chrome-plated surfaces should be avoided except for simple flat parts. Because most parts are more complex, a vapor-honed matte surface is recommended to provide the easiest, most trouble-free release. Ejector pins should have as large a surface area as possible, especially those located at thick part sections where the interior may still be very soft at the time of injection. Stripper plates and air ejection systems may also be used with Lubrizol TPUs.

VENTS

Vent should be cut only after initial trials on the new tool have indicated necessary locations. A vent channel 6.4 to 12.7 mm (0.25 to 0.50 in.) wide by .03 mm (0.001 in.) deep is usually sufficient. See Figure 5.

1. Vent
 2. Mold Vent
 3. Plastic Part
 4. Feed Runner
 5. Mold Cavity
- A. 0.001-0.002
 B. 0.100-0.150
 C. 0.500 Typical
 D. 0.400 Minimum

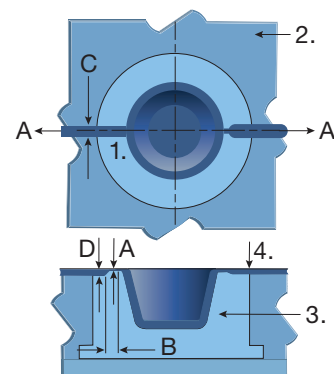

Figure 5: Mold Venting

The Molding Operation

PROCESSING PARAMETERS

Successful processing of Lubrizol TPUs by injection molding is very dependent upon a wide range of variables such as machine size, shot size, screw geometry and mold design. Due to these factors, exact machine conditions for optimum processing have to be determined by the processor for the system chosen. The sections that follow will define the conditions, which a molder should strive to achieve with Lubrizol TPUs. The best processing latitude and ultimate properties in the molded part will then be realized. Finally, start-up and shutdown procedures are summarized in the Processing Guide section. This section and the Trouble Shooting Guide section should be readily available to set-up personnel and machine operators.

DRYERS

Lubrizol TPUs are fully reacted thermoplastic polyurethane materials and will not react when exposed to atmospheric moisture. But, as with all polyurethanes and many other thermoplastic materials, Lubrizol TPUs must be dry when molded. All thermoplastic polyurethanes dissociate to some degree when heated to a molten state in an injection-molding machine. They recombine when cooled in the mold. If moisture is present it will interfere with the reformation and a lower molecular weight polymer will result.

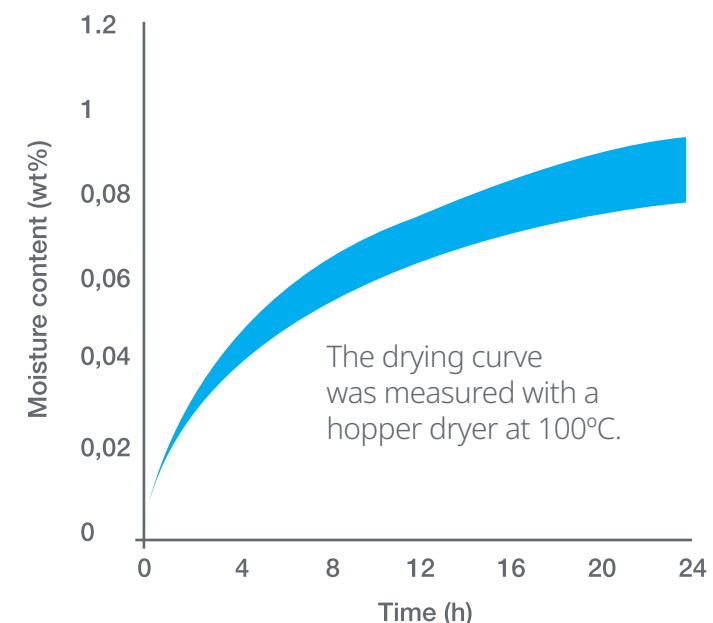
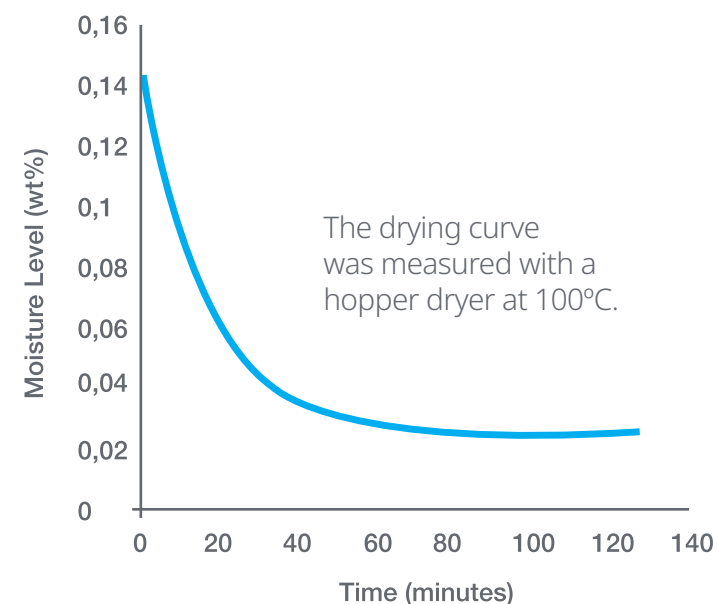

Figure 6: Drying and Moisture Absorption curves

For a small volume of material, an oven dryer is satisfactory. The Lubrizol TPUs should be spread in the trays one-inch deep and dried for two hours at 105°C (220°F). When larger volumes of material make oven drying impractical, a dehumidifying hopper dryer is recommended. A -30°C (-20°F) maximum dew point or a 0.02% moisture content or less should be obtained before the material is molded.

Polyurethanes are hygroscopic and will absorb moisture when the containers are opened to the atmosphere. The amount and rate of absorption will depend on the type of urethane as well as the temperature and humidity of the air to which it is exposed. Excessive moisture can also cause splay, voids, and parts sticking to the mold, and a severe reduction of the service life of the part. FIGURE 6 shows additional information related to drying and moisture.

PURGING

The machine should be thoroughly purged before and after molding Lubrizol TPUs. The best materials are LDPE, PE and GPPS. Lubrizol TPUs purge readily from the machine. Purging should be done immediately after the production run while the material is still molten. If the machine is allowed to cool to room temperature, purging can be more difficult because the cold material will stick tenaciously to the screw and on reheating, is difficult to remove.

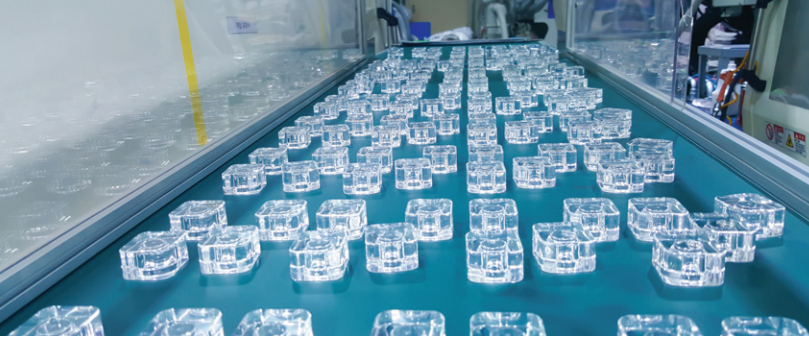

The Molding Operation

STOCK TEMPERATURE

The stock temperature can be controlled by a proper combination of the heater band settings, screw backpressure and screw RPM. To develop ultimate physical properties, it is important that recommendations for stock temperature be followed when molding Lubrizol TPUs.

To measure stock temperature, use an accurately calibrated needleprobe pyrometer. When making a temperature measurement with a needle pyrometer, the molten material should be injected directly from the nozzle onto a piece of heavy cardboard or some other insulating material that will not absorb heat from the plastic. The injection pressure, injection speed and back pressure are normally at a lower setting for taking these airshots than when at normal cycle; therefore, a stock temperature of approximately 5°C to 10°C (9°F to 18°F) lower than the recommended range is a good objective when starting. The needle should be jabbed into the molten plastic successively four to five times in different locations before the actual reading is taken.

Occasional wiping of the needle probe with some mold release agent will help prevent 'freezing' of plastic on the probe during the initial portion of the reading. If material 'freezes' to the probe on the first insertion, it acts as an insulator on the probe's surface and erroneously low values for stock temperature will be obtained.

If gassing or bubbling of the hot plastic is observed during the air-shot, it generally indicates a higher than recommended stock temperature is being achieved and/or excessive moisture. Stock temperature and moisture content should be rechecked. The molten plastic rope should appear smooth and reasonably glossy if the stock temperature is near optimum.

HEATER BAND SETTINGS

To achieve a given stock temperature, heater band settings depend greatly on machine size, screw design and other settings such as backpressure and screw RPM. Large machines typically yield stock temperatures higher than the heater band settings.

For the initial trial of Lubrizol TPUs an ascending barrel temperature profile from rear to front zones is recommended. These settings should be adjusted to achieve an air-shot, stock temperature 5°C to 10°C (9°F to 18°F) less than the final desired temperature (more heat will be generated once the machine is cycling continuously). Since heat is being generated by the screw within the material, it is quite normal for the middle and front barrel temperature zones to override the set point. As long as the machine is cycling regularly, these set points do not need adjustments. Carefully monitor stock temperature during initial start-up and after any condition changes.

NOZZLE TEMPERATURE

The nozzle should be controlled to the same temperature as that of the melt. This will prevent material from setting up between shots and will not cause any degradation from overheating. Care should be taken so that there are no cold spots in the nozzle area. The full length of the nozzle should be covered with heater bands as close to the tip as possible. Inadequate coverage by the heater bands can produce cold spots and allow some of the material to set up between shots. The result will be that the parts will contain lumps of material that were carried into the cavity by the melt stream.

INJECTION SPEED

A slow-to-moderate injection speed should be used at the start of the molding run and increased to the point where the part fills and no signs of weld lines or sinks exist. If the injection speed is too fast, excessive frictional heat buildup can result in velocity burning as the material flows through restrictions or over sharp edges. This frictional heat can result in surface appearance problems, or even degradation of the material. Injection speeds for air-shots should be relatively slow since there is very little resistance to the material flow.

A good rule of thumb for the injection speed is to use a time of two seconds per inch of ram travel.

SCREW BACKPRESSURE

The proper value for screw backpressure will vary from machine to machine, but generally the backpressure should be in the 0.3 to 0.7 MPA (50 to 100 psig) range. Low compression ratio screws may require back pressures.

SCREW RPM

For a screw of recommended geometry, a rotating speed of 40 to 50 RPM should be satisfactory. Large machines generally require less RPM at optimum conditions. Due to increased diameter, a larger screw has a greater circumferential velocity than a smaller screw at a given RPM. The greater velocity promotes more shear heating of the molding TPU.

INJECTION AND HOLDING PRESSURES

Filling the mold is best done using position transfer at 99% full during the first stage injection using velocity control. A short pack pressure stage at a pressure of 80% to 100% of the actual measured filling pressure is used to fill the cavity without flashing. Followed by a holding pressure to continue packing the part as it cools before the gate freezes. The holding pressure varies with part thickness but typically is slightly less than the actual measured stage 1 injection filling pressure. Screw should not bottom out and ¼ cushion should be maintained to accommodate any shrinkage until the gate is completely frozen.

Over packing the part with excessive holding pressure or time on the first stage injection pressure increases molded-in stress that is detrimental to properties. Generally, sink marks opposite the gate indicate that more injection pressure/time is needed. Once it is apparent that gates are frozen off, hold pressure can be reduced to save on energy consumption. A small cushion must be maintained ahead of the screw to compensate for part shrinkage as it cools under holding pressure, thus preventing sink marks. Ideally, the screw should only reach full forward position when material movement has ceased.

COOLING TIME

Except for parts with very thick sections, over 9.5mm (3/8-in.), the time required to retract the screw after the holding pressure is released is generally sufficient for cooling Lubrizol TPUs. The mold can be opened immediately after the screw stops. In general, the harder the TPU, the faster the set-up time. The cooling time required for a 75A versus a 55D polyester TPU, for example, may be two to three times as long as that required.

COLORANTS

Lubrizol TPUs may be colored by adding color masterbatches. The chemistry of the carrier resin to the type of TPU being used in the process may need to be the same. Since most TPUs commercially molded are polyester grades, off-the-shelf color masterbatches may usually be based on a polyester TPU rather than a polyether type. Having a specialty masterbatch made could be required, especially in the case of aliphatic TPU, it is better to use an aliphatic-based carrier.

Unless there is a protocol requiring that concentrates match the identity of the resin being molded, making a special concentrate with the same grade being used is not necessary for successful coloring. It is best if the TPU masterbatch has been made from a softer TPU than that being molded. In cases where the TPU being molded is a hard grade (e.g., ~50D or higher), please consult technical service or your sales representative.



Summary

SUMMARY

In summary, to develop the ultimate physical and appearance properties for Lubrizol TPUs, the material should be at the maximum allowable stock temperature in a fully dried state. It should be injected at a moderate speed, packed at the minimum pressure required to fill out the mold details and allowed to relax during the cooling stage.

Start-Up Procedure

START-UP PROCEDURE

Thoroughly clean the injection unit by either physically dismantling and cleaning or by purging the barrel with polystyrene, general purpose ABS or acrylic.

Set temperature controllers and reduce injection pressure settings, back pressure setting and screw RPM to the lower end of their operating ranges.

After temperature zones have stabilized, introduce the Lubrizol TPU into the machine.

Take air-shot stock temperatures and make adjustments to temperature settings and screw RPM to approach the desired stock temperature. Observe the appearance of the molten plastic very carefully at this stage. A smooth, glossy surface is indicative of a good homogeneous melt, while a bumpy rope and matte surface indicate non-homogeneity and low melt temperature. A smoking or frothy melt suggests that the stock temperature is too high or has excessive moisture. Another evidence of good melt temperature is the ability to draw down the hot rope into a thin monofilament.

A brittle break indicates a low melt temperature. Backpressure should be set to achieve adequate mixing and optimum melt temperature.

Spray some mold release in the cavity and sprue bushing and move the nozzle into position against the sprue bushing. Start molding parts in the semi-automatic mode of operation while adjusting screw travel (feed) injection pressures and injection speed to obtain a full part.

Consult the Trouble Shooting Guide for correcting any defects in the molded part.

Trouble Shooting Guide

Here are some typical molding problems and several possible causes for each:

PROBLEM	POSSIBLE CAUSES
SINK MARKS OR DIMPLED	<ul style="list-style-type: none"> • Shot too small • Holding pressure too low • Holding time too short • Gates too small or in wrong location • Injection speed too fast • Stock temperature too high • Mold temperature too high • Cooling time too short • Sprues, runners or gates too small
SHORT SHOTS	<ul style="list-style-type: none"> • Insufficient material • Injection pressure too low • Injection speed too slow • Cylinder temperature too low • Mold temperature too low • Insufficient venting • Sprues, runners or gates too small
SPLAY	<ul style="list-style-type: none"> • Material not dried properly • Melt too hot • Injection too fast • Gates too small
UNFLUXED GRANULES IN PART	<ul style="list-style-type: none"> • Barrel temperature profile wrong. • Too cold in the rear and middle zones. • Cold spots in the nozzle or nozzle adapter • Cold spots in the hot runner
FOAMY APPEARANCE IN PART	<ul style="list-style-type: none"> • Melt too hot • Excessive moisture
SWELLING OR BALLOONING OF THICK SECTIONS	<ul style="list-style-type: none"> • Melt too hot • Excessive moisture • Cooling time too short • Mold temperature too high

Lubrizol Locations

AMERICAS

Lubrizol Advanced Materials, Inc.
9911 Brecksville Road
Cleveland, OH
44141-3201
USA
Phone:
+1.888.234.2436

ASIA

Lubrizol Specialty Chemicals Manufacturing (Shanghai) Co, Ltd., 6-F - No.3, Building C, Lane 227 Dongyu Road Shanghai PRC 200126
Phone:
+86 21-3866-0366

EUROPE, MIDDLE EAST, INDIA & AFRICA

Lubrizol Advanced Materials Spain S.L.
Gran Vial, no. 17
08160 Montmeló (Barcelona)
Spain
Phone:
+34 93-579-9522



LUBRIZOL GLOBAL PRESENCE

Our global presence means we have the application and development laboratories (with technical service ability) already in place, as well as worldwide production capabilities and renowned customer service. We are also a specialty producer of performance coatings and other unique products for apparel. Teaming with Lubrizol simplifies a complex global supply chain.

Lubrizol



The information contained herein is believed to be reliable, but no representations, guarantees or warranties of any kind are made as to its accuracy, suitability for particular applications or the results to be obtained. The information is based on laboratory work with small-scale equipment and does not necessarily indicate end product performance. Because of the variations in methods, conditions and equipment used commercially in processing these materials, no warranties or guarantees are made as to the suitability of the products for the applications disclosed. Full-scale testing and end product performance are the responsibility of the user. Lubrizol Advanced Materials, Inc. shall not be liable for and the customer assumes all risk and liability of any use or handling of any material beyond Lubrizol Advanced Materials, Inc.'s direct control. The SELLER MAKES NO WARRANTIES, EXPRESS OR IMPLIED, INCLUDING, BUT NOT LIMITED TO, THE IMPLIED WARRANTIES OF MERCHANTABILITY AND FITNESS FOR A PARTICULAR PURPOSE. Nothing contained herein is to be considered as permission, recommendation, nor as an inducement to practice any patented invention without permission of the patent owner.

Trademarks owned by The Lubrizol Corporation or its affiliates. ©The Lubrizol Corporation 2025, All Rights Reserved.

<https://go.lubrizol.com/EP>

25-0004565